

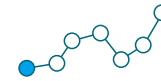

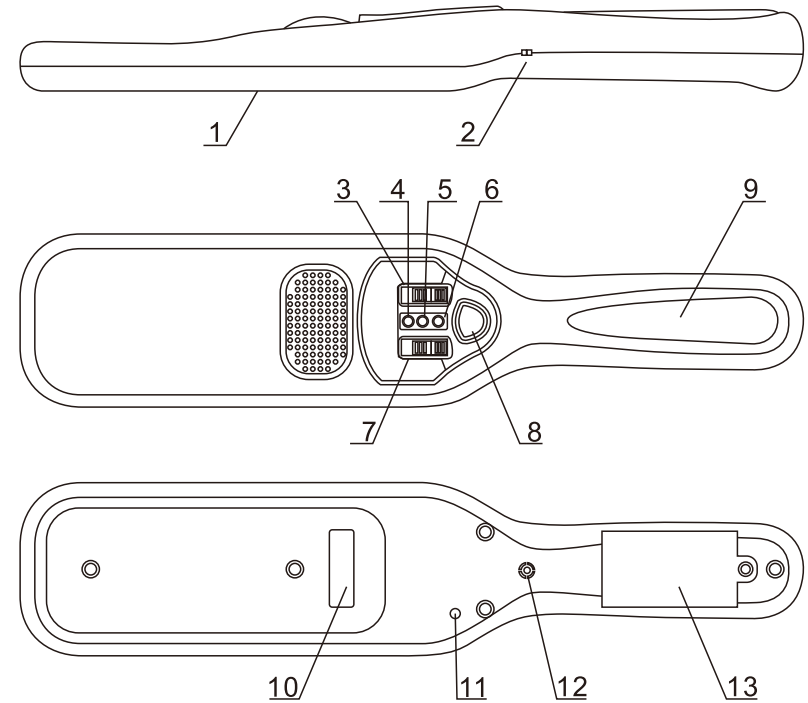

HAND HELD HIGH SENSITIVITY METAL DETECTOR

Operating Manual



Product Introduction



- 1.Metal detection panel
- 2.Lanyard hole
- 3.Sensitivity adjustment (L: Low sensitivity M: medium sensitivity H: high sensitivity)
- 4.5.6: Indicator light (Red: metal alarm; Yellow: Low power indicator; Green: Power indicator)
- 7.Alarm mode adjustment ( ring bell,  silence,  vibration)
- 8.Power switch
- 9.Handle
- 10.Label position
- 11.Sensitivity adjusting hole
- 12.The speaker hole
- 13.Battery cover



Basic Parameters

- ※ Dimensions: L360mm x W80mm x H41mm
- ※ Power supply: 2 AA batteries
- ※ Working temperature: -25°C~+60°C
- ※ Humidity: 0~95%

Detection Distance:

- ※ Pin: 30~60mm;
- ※ Type 64 pistol: 150mm;
- ※ Six-inch dagger: 160mm
- ※ Diameter 20mm steel ball: 90mm

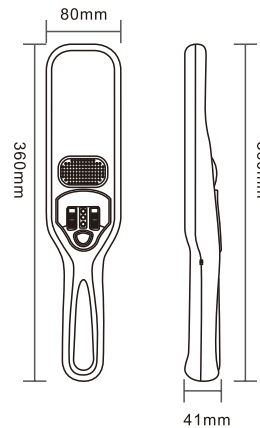

Product Features

- ※ High sensitivity;
- ※ Convenient and simple use, no need to adjust;
- ※ Low electricity, can work for 40 hours continuously;
- ※ There are automatic continuous alarm once battery used up.
- ※ There are voice indicator for power on and off.
- ※ There are switch button for sound, LED and vibration.



Replace The Battery:

- ※ Loosen the screw with a screwdriver to open the back cover of the battery compartment.
- ※ Insert No. 5 AA (1.5V) batteries correctly according to the positive and negative symbols in the battery box.
- ※ Close the battery cover lock screw.

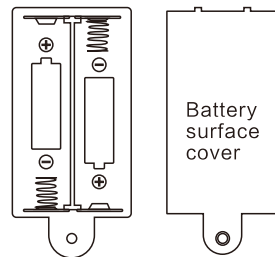

Method Of Use

- ※ Turn on the device you will hear a clicking sound, indicating that the power is on, and at the same time the green light is on. If there is no sound, it means that the battery is not installed or the battery is in poor contact. If the sound happens continuously, it means that the battery can no longer be used, and you should replace a new one.
- ※ Then high-sensitivity detection can be performed. Hold the handle to scan the detection surface around the object. When there is a metal object, an alarm will sound, and at the same time, the green light will change to a red light. If stop scanning, the alarm will stop, and the red light changes to green light.



Sensitivity Adjustment

- ※ If the detection distance does not meet the specified requirements or the sensitivity is too high to cause instability or sound when the human body is scanned without metal, the sensitivity should be adjusted.
- ※ Use a small flat-blade screwdriver to penetrate the small hole on the detector handle and rotate it clockwise until it has sound, and then turn it counterclockwise until it stops make sound, and then rotate it counterclockwise for half a turn until the sensitivity meets the requirements.



Product Usage

- ※ Electronic metal detection inspection at airports, prisons, customs, stations, terminals
- ※ Security inspections at Customs, public security, border defense
- ※ Pharmaceutical and food business system quality inspection
- ※ Important place, sports field safety inspection
- ※ Precious metal detection, such as gold and silver jewelry factories, electronics factories, hardware factories, warehouses, etc.



Attention

- ※ Please use the specified battery and don't forget to turn off the power after use.
- ※ Please remove the battery when it is not applicable for a long time.
- ※ The device does not make a sound when it is fixed to a metal object. And it only makes a sound when it sweeps over a metal object.
- ※ Do not mix old and new batteries, and batteries of different types.
- ※ Please dispose of the replaced old battery according to local regulations.