



Newest Version 5.2V

300 Anti-interference Series Cross Beam Walk Through Metal Detector

Cross Beam
Walk Through Metal Detector

INNOVATION

Advanced US Arsenal
technology; unique
exterior design; flexible
component connection;
simple and quick
disassembly; excellent
waterproof
performance; built-in
various detection
procedures, to meet the
needs of different
occasions; simple
operation and complete
portability; it is a major
undertaking of the

INNOVATION



300 Anti-interference Series Cross Beam Walk Through Metal Detector

Modular products, Easy maintenance,
Special materials,
High strength and Lightweight,
Assembly line, Altra-high precision

The led display metal detection door is a high performance metal detection door, the metal detection sensitivity of this kind of safety detection door is higher, with waterproof, lightweight and anti-interference strong, stable performance characteristics.the product use high strength special material, the quality of a material is very light, easy to transport installation.product modular design, unified assembly line, so it can well ensure the stability of the product. At the same time it also has the operation interface , simple to use.

300 anti-interference series walk through metal detector can be widely used in sports, meetings, schools and other occasions.

This product has obtained appearance patents, and has obtained the software system registration right.this product uses electromagnetic field to detect the detection structure of carry-on metal objects, and uses sound and light alarm to indicate that the carry-on metal objects of the passer exceed a certain amount.it is composed of host, high frequency signal generator, signal receiver and infrared sensor.it has the characteristics of beautiful appearance, strong metal detection ability, multiple detection defense areas, unique internet remote operation management system, portability and waterproofing.leading in the forefront of the market metal detection door.



Environmental Adaptive Function
(It can automatically eliminate the interference of fixing small metal in the surrounding environment of the equipment)

Operating Instruction



1

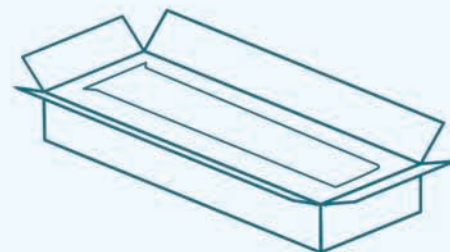

2



Leading Technology

- Multi-zone Technology :6/12/18 zones detection or self-switching, intelligent zones (It can provide more zone upgrade technology)
- Working Frequency Band: ultra-wide working frequency band (0-50), with the function of adapting to the working environment.
- Detection Sensitivity Of Defense Area: the sensitivity of a single defense area can be up to 400 levels
- Fault Code Indication Function: when the equipment fails, jump out of the corresponding code to facilitate maintenance.
- Adaptive Diagnosis System: when the system is started up, the adaptive diagnosis and detection hardware will work to escort you.

Product Advantage

- Adaptive debugging system: the system can be adaptive debugging detection standard when entering the debugging system
- Start-stop technology: the infrared device has automatic start-stop technology, and its life is extended 100 times.
- Recording sensitivity of each detection defense area can be adjusted arbitrarily (with adaptive regulation technology)
- The detected defense area can be divided by self-adjustment (the number of detected defense areas can be compiled by itself)
- Sound and light alarm, alarm tone and alarm duration can be adjusted arbitrarily
- Query function: the system has real-time information query function.
- Detection ability: have the detection passing ability of more than 100 people in 1 minute.

Technical Specification

- Test Objects: prohibited items, including mobile phones and metal;
- Dimension: 2200x850x340mm;
- Channel Size: 2000x720x340mm (Width can be customized 720~1500mm);
- Package Size: 2270x640x230mm;
- Working humidity: 99%, no condensation; ● Working environment: -20℃~85℃;
- Power supply: the whole system is equipped with polymer batteries, with a life time of 8, 16, 24, 48 and 72 hours (optional);
- Input: AC 100V~240V/50HZ~60HZ ● Output: DC 12V/4.2A 12W
- Weight: N.W.: 33KG G.W. :40KG;



Equipped with 3 sets of digital display, at any time to understand the number of people through and alarm

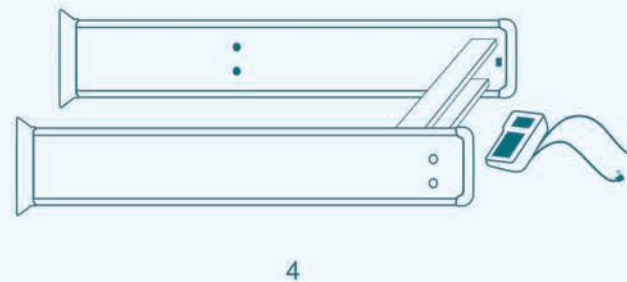
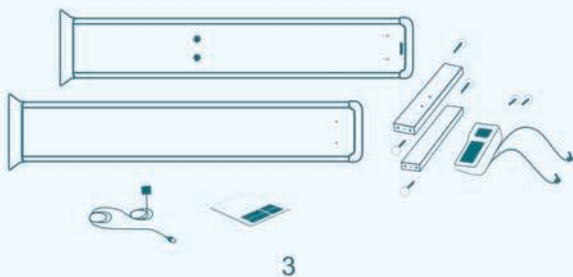



Fault Diagnosis And Fault Code Function

In order to equipment failure, the user and maintenance personnel can quickly solve the problem, the developers join the fault code system.

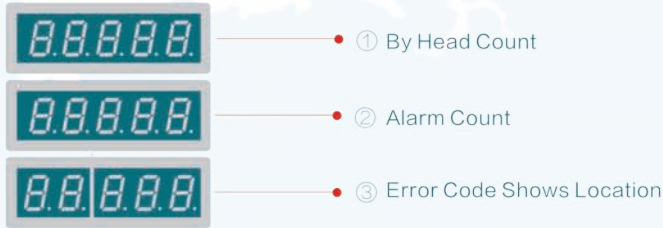

When the equipment shows fault code, please check the equipment first according to the "Common Fault Handling" section of the manual. In case of failure, please contact the manufacturer in time.

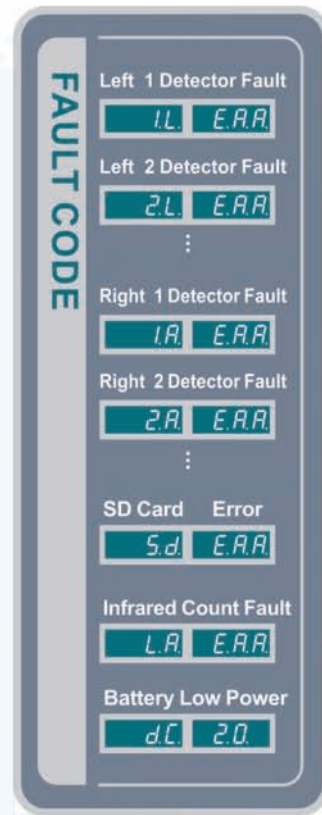

Product Upgrade Comparison

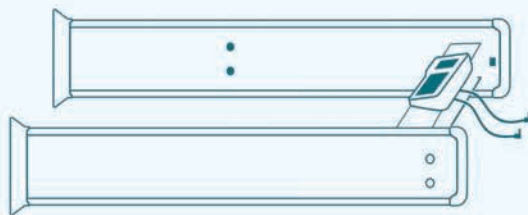
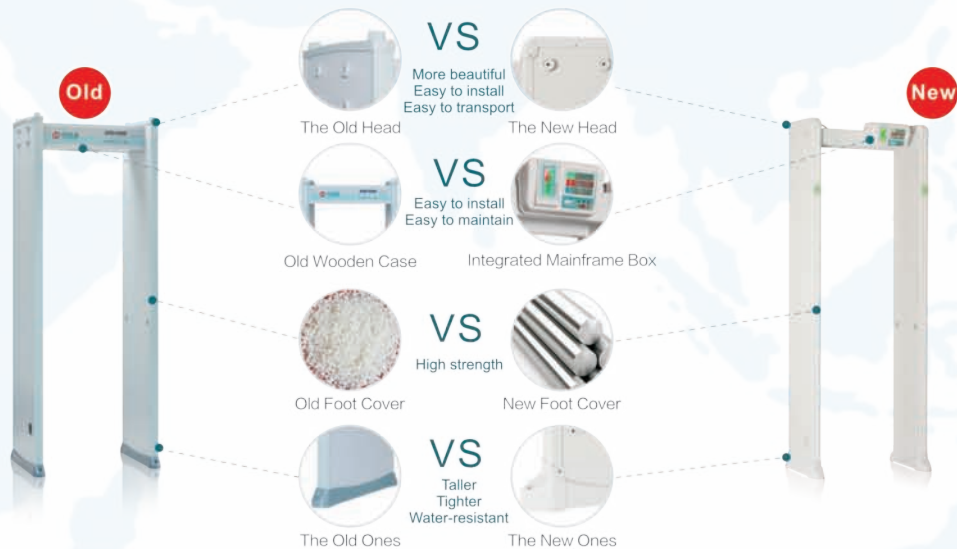

5

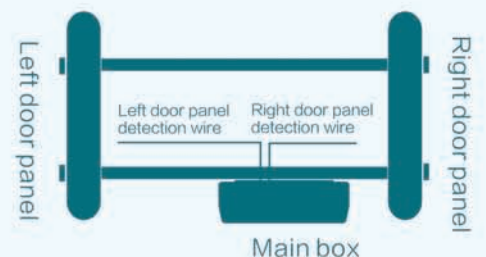

6



Special Function

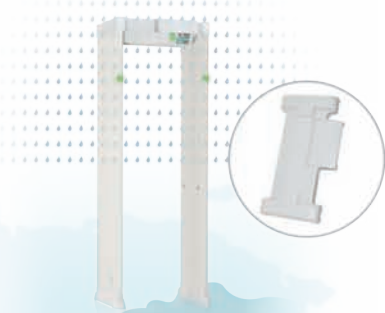

- **Outdoor Semi-rainproof Type**
The equipment is equipped with special rainproof cover (optional), which can work normally in light rain environment



- **Quick Settings For Application Scenarios**
The device is equipped with 72 kinds of working scene setting data, which is convenient for users to switch at any time and adapt to various kinds of detection needs.

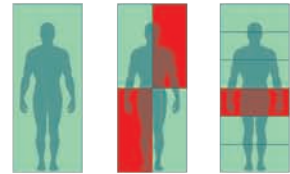

Single Zone 4 Zones 6 Zones

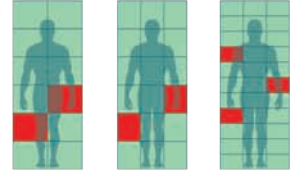

12 Zones 18 Zones 33 Zones

- **Multiple Detection Locations are available**
1/4/6/12/18/33 Zones (Custom)



-20°C
85°C

- **Anti-High And Low Temperature**
The equipment can be normal in the environment of -20°C to 85°C (Customized)



- **Super Long Power Supply Time (Customized)**
The whole system is equipped with polymer battery, which is convenient for outdoor and temporary security inspection activities. The battery life is 8, 16, 24, 48 and 72 hours (optional).

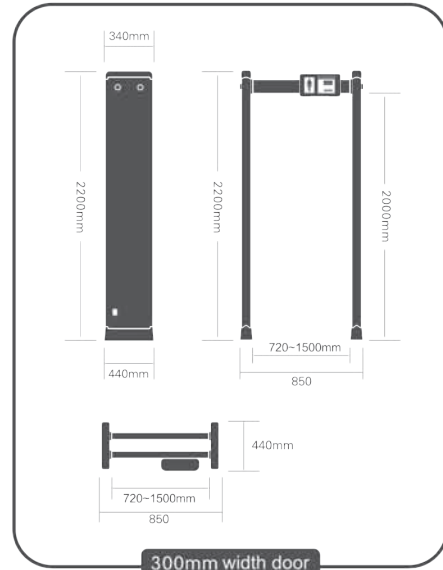

Packing Specification



Package size:: 2270x640x230mm
 Volume: 0.334m³
 N.W. : 33KG
 G.W. : 40KG

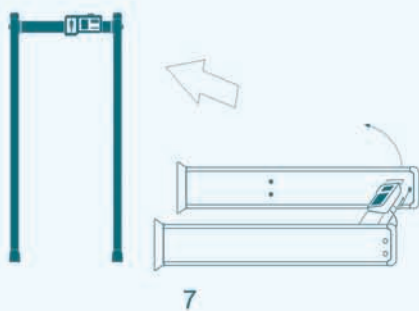

7



8